

# ***CBA A2 Amplifier 2000W System***



**[www.westmountainradio.com](http://www.westmountainradio.com)**

1020 Spring City Drive

Waukesha, WI 53186

262-522-6503

[sales@westmountainradio.com](mailto:sales@westmountainradio.com)

©2022 West Mountain Radio, All rights reserved. All trademarks are the property of their respective owners.

---

Thank you for choosing the CBA Amplifier 2000W System for making testing batteries at high rates easier than ever.

The amplifier is very simple in concept. It is a DC amplifier that amplifies and regulates discharge current with a total (CBA and amplifier together) amplification factor of 20 times (20X). The CBA is actually doing 1/20 of the discharge and the amplifier is doing the other 19/20. The amplifier simply senses the current drawn by the CBA and amplifies the discharge current setting of the CBA for total of ten times the set current.

The 2000 watt system has four amplifiers connected in parallel using the custom harness included. It is important that these connections are balanced in resistance in order for the load to be shared equally between both amplifiers. Read the connection information carefully.

The amplifier used in this system uses 20X Gain. The amplifiers used in the 500W and 1000W setup use 10X Gain. It is for this reason that you cannot use an individual amplifier in this system, they must remain grounded together for a 2000W setup.

**IMPORTANT:** Both amplifiers should be used with the latest CBA software (version 2.1 or later).

## Recommended Usage

The CBA amplifier is designed and recommended only for commercial or industrial use. It is not intended for a hobbyist, as it will easily test batteries at destructive limits. We DO NOT recommend testing batteries at advertised maximum ratings as these ratings may be written for sales purposes instead of scientific reasons. Unless you are extremely knowledgeable about batteries, do not attempt testing at maximum ratings. Even if a manufacturer was truthful about these ratings, maximum discharges may significantly shorten the cycle life of a battery.

Testing at maximum ratings should never be necessary to tell if a battery is good or bad. A 1C or less discharge will tell you if the battery is meeting capacity specs and whether or not it is good. That should be all you need to determine if you can continue to use a battery. Testing at maximum discharge ratings is only necessary to tell whether or not a battery is safe at those ratings, how much the cycle life is shortened or if it will overheat and sustain damage or ignite.

---

## Safety Precautions

The West Mountain Radio CBA when used with the amplifier is inherently safe but the batteries it tests are not. Anything that stores energy is potentially dangerous! A can of gasoline can be safe if treated properly but imagine what can happen. Some types of batteries are safer than others but they are all capable of causing explosions or fires.

### Primary safety considerations:

Never discharge a battery at a higher discharge rate than it is designed for. Do not assume that the manufacturer's ratings are correct. Testing at a higher discharge rate than 1C (one hour) may damage a battery. High discharge rate specifications are usually an intermittent or peak rating and most batteries will not sustain a 100 % discharge at these rates without overheating and damage.

- Never use a battery that has poorly insulated or frayed wiring or exposed metal parts.
- Never short out or connect a battery with reverse polarity.
- Never test a battery near flammable materials.
- Never allow a battery to reach a temperature that causes it to get so hot that it may be too hot to touch.
- Never test or discharge your batteries while unattended.
- Have a fire extinguisher nearby

### CBA and amplifier operating precautions and requirements:

- Never connect a battery with the polarity reversed!
- Always turn off the amplifier, using the power switch, before connecting a battery.
- Never attempt to test a battery with any type of temporary or low current connection!

The battery must be solidly connected to the amplifier with bolts. Attempting to use jumper cables or alligator clips is dangerous! Any intermittent connection could cause the amplifier to momentarily go full on to try and maintain the current. When the connection is re-established there will be a near infinite current spike possibly damaging the amplifier.

---

Do not leave a battery connected if you are not running a test. (There is a residual current drawn from the CBA and amplifier that will discharge a battery over long periods of time even if a test is not being run.)

Operate the CBA and amplifier in a cool dry location.

Never allow metal parts or wiring of the battery to come in contact with the CBA's heatsink or amplifier's metal case.

Never test a battery that is also connected to some other equipment, such as a charger or the device that the battery is intended to power. The only exception to this is a device such as a battery powered meter which is totally isolated from the rest of the system.

Never allow the cooling fans to be blocked or jammed. Do not use the CBA's or amplifier's fans to cool your batteries.

Do not ignore the warnings that our software may give you.

Never exceed the 2000 watt continuous rating of the CBA combined with the amplifier. To calculate watts multiply the fully charged battery voltage in volts times the current in amps. You may divide 500 (watts) by the measured fully charged battery voltage to determine the current that will produce the 2000 watt maximum.

**DO NOT USE THE NOMINAL AVERAGE BATTERY VOLTAGE RATING; USE THE FULLY CHARGED VOLTAGE!**

Never use the CBA on an external USB hub or with a computer that has screen saver, hibernate or sleep modes enabled.

Do not plug in or disconnect other USB devices while running a test. (Windows momentarily suspends USB communications and our software and firmware instantly stops a test if USB communications is lost to insure safe operation.)

The CBA or amplifier can get hot. Do not touch the metal heat sink during, or shortly after a high power test.

---

Always monitor a battery's temperature during a test. You may use the CBA temperature probe to automatically terminate a test with high battery temperature. The trigger temperature should be set somewhat lower than what might be safe as it is difficult to measure at the center of a pack where the temperature is the highest. Take into account that the inside of the pack may be much hotter than the outside surface. For an instantaneous reading of temperature you may wish to use a good quality IR thermometer. Note: the CBA temperature probe should be calibrated near the temperature of interest. Our probe requires an intimate thermal contact with the pack in order to read the actual surface temperature of a battery and it should be mounted with tape to minimize external cooling effects.

Do not operate the CBA within close proximity of any radio transmitter, in strong RF fields or with any radio transmitter within a few feet. This includes walkie-talkies, RC transmitters and cell phones.

#### Lead acid battery safety warnings:

This warning may not be a consideration while testing a battery with the CBA but it certainly is while charging lead acid batteries. These batteries, especially automotive and marine types, give off explosive hydrogen gas when charged. A nearby or internal spark or flame can cause a lead acid battery to explode, sending liquid acid and lead shrapnel in all directions. This possibility is particularly dangerous and frequently causes blindness or severe scarring injuries.

Never use a standard lead acid battery without proper ventilation. Sealed lead acid batteries such as gelled or AGM (absorbed glass mat) types are much safer. Flooded electrolyte vented automotive and marine batteries are not as safe and should be used in protective ventilated housings, such as under the closed hood of a car.

Never make the last connection to a lead acid battery causing a spark on the terminal. Always connect the load or charger last, and at a safe distance away from the battery.

---

## NiCad, NiMH, and Alkaline safety warnings:

These batteries can be dangerous also. If they are shorted out, or charged or discharged at too high a rate, they can overheat and explode. A single D size NiCad cell can actually melt a 10 penny nail, don't try this!

## Lithium safety warnings:

Reprinted with permission of the Academy of Model Aeronautics  
Words in “( )” were added by West Mountain Radio

### ***Lithium Battery Fires***

Lithium batteries are becoming very popular for powering the control and power systems in our models. This is true because of their very high energy density (amp-hrs/wt. ratio) compared to NiCads or other batteries. With high energy comes increased risk in their use. The, principal, risk is FIRE which can result from improper charging, crash damage, or shorting the batteries. All vendors of these batteries warn their customers of this danger and recommend extreme caution in their use. In spite of this many fires have occurred as a result of the use of Lithium Polymer batteries, resulting in loss of models, automobiles, and other property. Homes and garages and workshops have also burned. A lithium battery fire is very hot (several thousand degrees) and is an excellent initiator for ancillary (resulting) fires. Fire occurs due to contact between Lithium and oxygen in the air. It does not need any other source of ignition, or fuel to start, and burns almost explosively.

These batteries must be used in a manner that precludes ancillary fire. The following is recommended:

1. Store and charge (discharge) in a fireproof container; never in your model.
2. Charge (discharge), in a protected area devoid of combustibles. Always watch over the charging (discharging), process. Never leave the charging process unattended.
3. In the event of damage from crashes, etc, carefully remove to a safe place for at least a half hour to observe. Physically damaged cells could erupt into flame, and, after sufficient time to ensure safety, should be discarded in accordance with the instructions which came with the batteries. Never attempt to charge (discharge) a cell with physical damage, regardless of how slight.

---

4. Always use chargers designed for the specific purpose, preferably having a fixed setting for your particular pack. Many fires occur in using selectable/adjustable chargers improperly set. Never attempt to charge Lithium cells with a charger which is not, specifically, designed for charging Lithium cells. Never use chargers designed for Nickel Cadmium batteries.

5. Use charging systems that monitor and control the charge state of each cell in the pack. Unbalanced cells can lead to disaster if it permits overcharge of a single cell in the pack. If the batteries show any sign of swelling, discontinue charging, and remove them to a safe place outside as they could erupt into flames.

6. Most important: NEVER PLUG IN A BATTERY AND LEAVE IT TO CHARGE (DISCHARGE), UNATTENDED OVERNIGHT. Serious fires have resulted from this practice.

7. Do not attempt to make your own battery packs from individual cells. These batteries CANNOT be handled and charged casually such as has been the practice for years with other types of batteries. The consequence of this practice can be very serious resulting in major property damage and/ or personal harm.

## **CBA Amplifier Connection and Use**

### CBA Quad Amplifier Harness Connection

Connect the Powerpole® 4-1 cord, single ends, to each amplifier's red and black Powerpole® connector marked "CBA". Connect the double Powerpole® end to the CBA's Powerpole® battery connector.

**IMPORTANT:** Do not place additional wiring or connections in between the CBA and the amplifiers.

Remove the bolts from the battery straps of the amplifiers and bolt the heavy 2 gauge 4-1 harness to the outputs, red to red and black to black.

Turn each amplifier on and check that each's LED power indicator light blinks green.

**NOTE:** The fans should not turn on.

---

## **CBA Dual Amplifier Battery Connection**

**IMPORTANT:** Turn off all amplifiers using the unit power switch before connecting a battery to the harness.

Use only the bolts on the output harness for the battery connection. NEVER put a battery directly across the amplifier straps. The current load would not be balanced, possibly causing damage or overheat one amplifier. Make the lowest resistance connection possible.

**NOTE:** Any additional resistance introduced by the method chosen to connect a battery will show up as reduced battery voltage and a proportionately lower capacity reading. A very low resistance connection to the battery is particularly necessary for high discharge rates. A poor connection, and/or cells with high internal resistance, may cause the system not to be able to regulate current at, up to, 320 amps down to 0.9 volts.

### **CAUTION! BE SURE THAT YOU CONNECT THE BATTERY WITH THE CORRECT POLARITY!**

**– minus / black to –**

**+ plus / red to +**

To use the amplifier, connect the CBA's red and black Powerpole® connector to the connector on the amplifier marked CBA. Do not place additional wiring or connections in between the CBA and the amplifier. If you have replaced the Powerpole® connector that comes with a CBA you should re-install a Powerpole®. We do not recommend using an adaptor.

Plug the supplied 15 VDC wall power supply into a 120 VAC 60Hz AC outlet. For international operation be certain that your amplifier was supplied with the correct wall power supply. Connect the DC plug of the power supply to the amplifier's DC input jack.

The incorrect polarity will cause the amplifier's FET body diodes to conduct the full current that the battery is capable of and possibly damage the FETs. If you do connect with reverse polarity, even if the battery is not capable of damaging the CBA and amplifier it will discharge a battery very quickly and could possibly destroy the battery or cause a fire!

When connecting any battery to anything be very careful not to short out the battery while making the connections. Damage or fire may result!

Anderson Power Products® and Powerpole® is a registered trademark of Anderson Power Products, Inc.



## CBA Amplifier Connection Examples

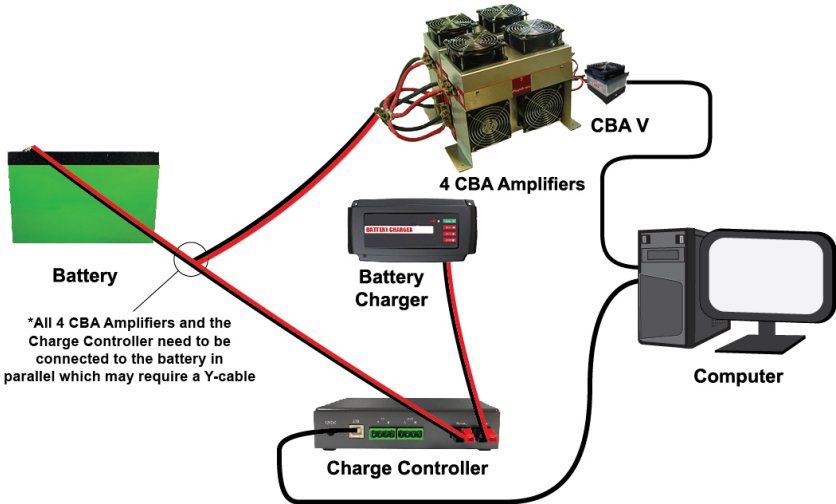

### Running a Test

Turn on the amplifiers and wait for the amplifier's green "operate" LED light begin to blink.

In the CBA Software new test window, be sure to check the selection labeled '2000 Watt' under 'Amplifier'. Failure to do so will result in a test being perform with 20 times more load than desired.

Select CBA Unit(s)      CBA # 50018

None (Multi-Unit Mode)

None (Multi-Unit Mode)

Amplifier

- No Amplifier
- 500 Watt
- 1000 Watt
- 2000 Watt
- 4000 Watt
- 8000 Watt
- 12000 Watt
- 16000 Watt

Start      Cancel

← **Select**

---

Tip: Leave the amplifier in-line, but switched off, and de-selected in the software, for discharge rates less than 100 watts (An amplifier is bypassed and disabled whenever it is powered off).

Run any test by using and understanding the operation of the software as explained in the software help files.

The “operate” button LED will light solid green to indicate normal operation during a test. A solid green light indicates that the CBA Amplifier is amplifying the current draw of the connected CBA.

The amplifier fans are controlled automatically and will turn on whenever one ampere or more is being drawn by the CBA or when the temperature of the heat sink has risen above 80 degrees Fahrenheit. The CBA amplifier is meant to run tests at 100 watts or more and the fans may not turn on, below 100 watts. At lower power settings the fans may take several minutes before they turn on automatically. This is normal. The fans will stay on until the heatsink temperature has fallen below 75 degrees Fahrenheit. Do not switch off the CBA amplifier power until the fans have stopped automatically.

When your test is completed, turn off the amplifier and disconnect your battery. The “Hi Temp” LED will be off in normal operation and it will blink when the amplifier temperature is near over temp.

If the amplifier cooling is blocked, or if for any reason the amplifier temperature gets too high, over temperature protection will be activated. When activated, the red “Hi” temp LED will light solid and the amplifier will stop the discharge, causing the current to drop to 1/20 of what you would expect. Note: you will notice a rise in the battery voltage if this happens. The amplifier must be power cycled at this point before it can be used again. Wait for fans to stop before cycling power.

The operate LED will light solid red if the CBA Amplifier has shut down for safety reasons.

Examples: Disconnected battery, a sudden drop in battery voltage or a battery voltage which is higher than the CBA Amplifier specifications allow.

## Specifications

<b>Dimensions</b>	5.5" H x 6.25" W x 13.75" D
<b>Max. Continuous Discharge Rate</b>	2000 W
<b>Discharge Rate Amplification (typical)</b>	20X +/- 1%
<b>Absolute Max. Operating Voltage</b>	57V
<b>Max. Discharge Rate</b>	320 A (3.12 V at test start) (battery dependent)
<b>Min. Voltage for 160A Discharge:</b>	0.9 V at test completion (battery dependent)
<b>Connectors</b>	Supplied copper bus 5/16 bronze battery connectors. Powerpole® CBA connector
<b>Fan Operation</b>	Auto sense 0.500 A or more current from CBA. (Stays on approx. 5 mins after test completion)

### Liability Disclaimer











West Mountain Radio will not be liable to you (whether under the law of contract, the law of torts or otherwise) in relation to the contents of, or use of, or otherwise in connection with, the CBA ("product"):

To the extent that the product may cause any bodily or equipment damage; For any indirect, special or consequential loss of any kind;

For any business losses, loss of revenue, income, profits or anticipated savings, loss of contracts or business relationships, loss of reputation or goodwill, or loss or corruption of information or data.

By using this product, you agree to the limitations of liability set forth in this disclaimer are reasonable.

West Mountain Radio CBA © 2015 by Custom Computer Services, Inc

Test Mode	Why use this test?	Standard Software	Extended Software	Operation
<b>Mission Profile</b>	<ul style="list-style-type: none"> <li>Defined Pass and Fail parameters</li> <li>Operated without detailed knowledge of the test</li> </ul>	✓	✓	
<b>Discharge</b>	<ul style="list-style-type: none"> <li>Measuring and analyzing battery capacity</li> </ul>	✓	✓	
<b>Dynamic</b>	<ul style="list-style-type: none"> <li>See how a battery or supply responds to different loads</li> <li>No need to stop or edit the test that is running</li> </ul>	✓	✓	
<b>Charge Monitor</b>	<ul style="list-style-type: none"> <li>Graphs voltage versus time</li> <li>Log and graph a battery or supply</li> <li>Log voltage of the battery as it is charged</li> </ul>	✓	✓	
<b>Power Profile</b>	<ul style="list-style-type: none"> <li>Characterizing different power supplies and solar cells</li> <li>Determine the maximum power they can provide</li> </ul>	✓	✓	
<b>Charge / Discharge</b>	<ul style="list-style-type: none"> <li>Perform life cycle test of the battery (see how its' capacity reacts after user specified number of discharge/charge cycles)</li> </ul>	✓	✓	 <p><small>*This test requires the West Mountain Radio CBA Charge Controller (purchased separately)</small></p>
<b>Duty Cycle</b>	<ul style="list-style-type: none"> <li>Evaluate the performance of a battery in an application which typically involves a cyclic or variable duty cycle</li> </ul>		✓	
<b>Constant Power</b>	<ul style="list-style-type: none"> <li>Test batteries that are used in systems which require consistent power</li> </ul>		✓	
<b>Multiple Discharge</b>	<ul style="list-style-type: none"> <li>Test battery applications that experience a variety of different current loads</li> </ul>		✓	
<b>Constant Resistance</b>	<ul style="list-style-type: none"> <li>Simulate a constant resistance load on a battery</li> </ul>		✓	
<b>Timed Discharge</b>	<ul style="list-style-type: none"> <li>Discharge the battery to a certain capacity</li> <li>i.e. a Lithium battery that needs to be at 30% charge before shipping</li> </ul>		✓	

## Software

Details on using the CBA software can be found in the Help area of the software. A PDF of the entire Help File can be downloaded from the West Mountain Radio website under SUPPORT>DOWNLOADS>CBA

# Troubleshooting

LED does not light on CBA	<ul style="list-style-type: none"><li>• Make sure both USB cables ends are in securely</li><li>• If a USB hub is used make sure it is a powered HUB</li><li>• Make sure the PC power settings have not powered down the USB port</li><li>• Try another USB port</li><li>• CBA unit might be damaged</li></ul>
Blinking orange LED	Check the device manager to see if there is a driver error flagged by Windows. If the CBA is not listed in the USB section check the “other devices” and “unknown devices” sections. Try re-installing the software.
Red flashing LED and/or No or very low voltage shows on the right side of the screen after a battery is connected.	<ul style="list-style-type: none"><li>• Verify cable from CBA PowerPoles to battery</li><li>• Replace the fus</li></ul>
Test stops as fast as it start	<ul style="list-style-type: none"><li>• Verify when the test is not running that the voltage shows right (if not see above)</li><li>• Verify the test stop criteria is as expected</li><li>• Expand the chart and if the voltage drops very fast you may be setting the current draw too high for the battery</li></ul>
During a test, noise appears on the chart	<ul style="list-style-type: none"><li>• As battery contacts heat up due to high current the metal changes size and can cause resistance changes.</li><li>• Tighten contacts that can be tightened</li><li>• Clean contacts that can be cleaned using alcohol.</li><li>• If there is vibration in the environment put CBA, cables and battery on a cushioned mat.</li><li>• Ensure cables that are crimped were properly crimped.</li></ul>
During a test, the test abruptly stops going to 0 volts.	<ul style="list-style-type: none"><li>• If the voltage is right when a test is not running this is due to the resistance of the battery cable. Solutions:</li><li>• Use the remote sense cable to get an accurate reading</li><li>• Use the extended software to calibrate the cable by accounting for the resistance.</li><li>• Use a heavier CBA to battery cable</li></ul>

## CBA A2 500W Amplifier Warranty

*CBA Amplifiers* warranted against failure due to defects in workmanship or materials for one year after the date of purchase from West Mountain Radio. Warranty does not cover damage caused by abuse, accident, misuse, improper or abnormal usage, failure to follow instructions, improper installation, alteration, lightning, or other incidence of excessive voltage or current. If failure occurs within this period, return the *CBA Amplifier* or accessory to West Mountain Radio at your shipping expense. The device or accessory will be repaired or replaced, at our option, without charge, and returned to you at our shipping expense. Repaired or replaced items are warranted for the remainder of the original warranty period. You will be charged for repair or replacement of the *CBA Amplifier* or accessory made after the expiration of the warranty period.

West Mountain Radio shall have no liability or responsibility to customer or any other person or entity with respect to any liability, loss, or damage caused directly or indirectly by use or performance of the products or arising out of any breach of this warranty, including, but not limited to, any damages resulting from inconvenience, loss of time, data, property, revenue, or profit, or any indirect, special incidental, or consequential damages, even if West Mountain Radio has been advised of such damages.

Except as provided herein, West Mountain Radio makes no express warranties and any implied warranties, including fitness for a particular purpose, are limited in duration to the stated duration provided herein.



[www.westmountainradio.com](http://www.westmountainradio.com)  
1020 Spring City Drive, Waukesha, WI 53186  
tel 262-522-6503 fax 262-522-6504